

 <p><b>Micro Detectors</b> Italian Sensors Technology</p>	<p>M.D. Micro Detectors Strada S. Caterina, 235 41122 Modena Italy Tel. +39 059 420411 Fax +39 059 253973 www.microdetectors.com info@microdetectors.com</p>	<p><b>CRO SERIES</b> <b>RETROREFLECTIVE AREA SENSOR</b></p>	<p><b>LANGUAGE</b></p>
		<p><b>Installation and Operation Manual</b></p>	<p><b>ENGLISH</b></p>

 <b>Micro Detectors</b> Italian Sensors Technology	M.D. Micro Detectors Strada S. Caterina, 235 41122 Modena Italy Tel. +39 059 420411 Fax +39 059 253973 www.microdetectors.com info@microdetectors.com	<b>CRO SERIES</b> <b>RETROREFLECTIVE AREA SENSOR</b>	<b>LANGUAGE</b>
		<b>Installation and Operation Manual</b>	

## SUMMARY

<b>1.0</b>	<b>ABOUT THIS DOCUMENT</b> .....	<b>3</b>
1.1	Function of this manual .....	3
1.1	Explanation of symbols .....	3
<b>2.0</b>	<b>SAFETY AND PROPER USE</b> .....	<b>3</b>
<b>3.0</b>	<b>PRODUCT DESCRIPTION</b> .....	<b>4</b>
3.1	Short description .....	4
3.2	Available models .....	4
3.3	Functions description .....	5
3.3.1	Behavior at power on .....	5
3.3.2	Teach in .....	6
3.3.3	Optics exclusion .....	7
3.1	Electrical drawing .....	8
<b>4.0</b>	<b>TECHNICAL SPECIFICATIONS</b> .....	<b>9</b>
<b>5.0</b>	<b>START-UP INSTRUCTIONS</b> .....	<b>11</b>
5.1	Mechanical mounting of CR models .....	11
5.1	Electrical installation .....	11
5.2	Alignment of CRO models .....	11
5.5	Display indications and diagnostics .....	12
<b>6.0</b>	<b>MECHANICAL DIMENSIONS OF LIGHT CURTAINS AND STANDARD ACCESSORIES</b> .....	<b>13</b>
6.1	Mechanical dimensions of CRO/10-010V reflex curtains .....	13
6.2	Standard Mounting accessories .....	13
<b>7.0</b>	<b>INSTALLATION</b> .....	<b>14</b>
<b>8.0</b>	<b>LIST OF AVAILABLE ACCESSORIES</b> .....	<b>14</b>
<b>9.0</b>	<b>PACKAGE CONTENT</b> .....	<b>14</b>
<b>10.0</b>	<b>CONTROL OF THE INSTALLED LIGHT CURTAINS</b> .....	<b>15</b>
10.1	Purpose of controls .....	15
10.2	Preliminary controls before start-up .....	15
10.3	Controls device efficiency .....	15
<b>11.0</b>	<b>CE-CONFORMITY DECLARATION</b> .....	<b>15</b>
<b>12.0</b>	<b>WARRANTY</b> .....	<b>15</b>

 <p>M.D. Micro Detectors Strada S. Caterina, 235 41122 Modena Italy Tel. +39 059 420411 Fax +39 059 253973 www.microdetectors.com info@microdetectors.com</p>	<b>CRO SERIES</b> <b>RETROREFLECTIVE AREA SENSOR</b>	<b>LANGUAGE</b>
	<b>Installation and Operation Manual</b>	

## 1.0 ABOUT THIS DOCUMENT

Please read carefully this document before installation, start-up, use and maintenance of **CRO** light curtains. This manual contains detailed instructions that must be carefully followed.

### THIS MANUAL IS NOT IN THE ORIGINAL LANGUAGE

#### 1.1 Function of this manual

This manual provides the user with the necessary instructions for safe and proper installation, electrical connection, start-up, use and maintenance of **CRO** light curtains.

#### 1.1 Explanation of symbols



##### Warning

A warning sign indicates the presence of potential hazards. It indicates procedures and behaviours which can be useful to prevent accidents. Read and follow these instructions carefully.



##### Indication

It refers to indications that can help to achieve better performances.



##### Symbol

The symbol identifies optical devices that have the reflex function.

## 2.0 SAFETY AND PROPER USE



##### Warning

This is NOT a protective device. Therefore, it should not be used to guarantee personnel safety.



##### Warning

CRO works in DC and with a low voltage (the maximum value is 30VDC); the proper operation is guaranteed only in the range indicated in the technical data. With voltages below 16V<sub>DC</sub> all outputs remain in the OFF state, with voltages in excess of 30V<sub>DC</sub> permanently, the device may be damaged. When the device is switched ON, outputs are inactive for a certain amount of time known as **power on delay** (see the following documentation).



##### Warning

Some optics emit visible light that do not have dangerous levels; the device is classified RG0 (Exempt Group) according to IEC 62471 standard: 2006-07.



##### Warning!

Please make sure that light curtains are used in proper environmental conditions. Manual or automatic calibration must always be carried out aiming at the best possible alignment. More than one calibration and alignment adjustment may be necessary to guarantee the best alignment. Check any reflective surface next to the light beams which may influence them. Check any transparent or similar panels which may change the beam angle of the light curtains. Prevent the light curtain's optical window from getting scratched or tarnished. Do not expose the receiver to strong natural or artificial light sources, including stroboscopic light. Do not expose the receiver directly to optical beams projected by other optical devices. Ensure that the ambient temperature does not exceed the stated limits. Keep in mind that smoke, vapour, liquids and powders may alter transparency of air or dirty the optical window. Dispose of unusable or irreparable devices always in accordance with national regulations regarding waste disposal.

 <b>Micro Detectors</b> Italian Sensors Technology	<b>M.D. Micro Detectors</b> Strada S. Caterina, 235 41122 Modena Italy Tel. +39 059 420411 Fax +39 059 253973 www.microdetectors.com info@microdetectors.com	<b>CRO SERIES</b> <b>RETROREFLECTIVE AREA SENSOR</b>	<b>LANGUAGE</b>
		<b>Installation and Operation Manual</b>	<b>ENGLISH</b>

### 3.0 PRODUCT DESCRIPTION

#### 3.1 Short description

**CRO** light curtains are photoelectric devices built according to the **IEC 60497-5-2** norms and they must **not** be considered as safety devices. Therefore they must **not** be used to guarantee operators' safety nor to protect users on dangerous machines. They must rather be used to detect objects reducing or obscuring the intensity of light beams that returns from the reflector.

The housing is in aluminium painted in blue **RAL5002**, size **20x36mm**, (20 mm refers to the front side). A groove on the back allows connection with T-shaped components. The top and bottom side are in black **PBT**, the optical window is in **PMMA**. Protection degree is **IP67**.

In all models of the series, **CRO** have two **LEDs** indicators: **Red** and **Green** in combination, indicate the states of the sensor (alignment, state optics and fault indication), they are arranged at the top of the curtain, the light is intense and diffused in all directions, this ensures a great visibility in all conditions.

All models in the **CRO** have an optic composed of a continuous array of **9x9mm** lenses with a step of **10mm**, **CRO** have seven lenses. The optical window has a height of **69mm**; the total height of the curtain is **107mm**.

Emitter and Receiver are alternate with the following sequence is: **E1, R1, E2, R2, E3, R3, E4** with reference the cable side. This allows to realize a continuous succession of **six pairs** of reflex elements; the emitted light is **polarized** and has a wave length of **617nm**.

The working distance is **0.2...5m** with reflector **RL106** and lower with smaller reflectors, the best detection capability is **6mm**.

All models of **CRO** series have a teach button (inductive teach could also be available) in the top of the curtain dedicated to the activation of menu functions: two levels of **Teach-in** and **Blanking**.

The **Teach\_G** (gross teach) select an excess gain equal to **2 times** the threshold, the **Teach\_F** (fine teach) select an excess gain equal to **1.2 times** the threshold; the latter should be used only if the system and the environment in which the product is used are clean and with an high mechanical stability.

The sensor does not use automatic systems of signal tracking, but its repeatability is based on a sophisticated control of thermal drift.

The **Blanking** of the beams, allows gradually eliminate pairs of beams; the active couples (E+R) may range from a maximum of six to a minimum of one.

This sensors has a standard output with M12 male flying connector (240 mm pigtail).

The **CRO** models have four interface circuits which can be combined in different ways depending on the model and the number of output cables:

- a) Supply 15...30V
- b) IO\_Link output (C/Q), PNP/NPN/PUSH- PULL
- c) Auxiliary output (Q): PNP/NPN/PUSH- PULL
- d) Auxiliary input, output mode selection LIGHT/DARK (NC/NO) or more.

#### 3.2 Available models

MODEL	OPTICAL PITCH	OPTICAL HEIGHT	BODY HEIGHT	OPTICS	SENSING RANGE	RESPONSE TIME	CONNECTOR	POLES	Interface	
	P	h	H	N°	Sn	Tr		No	INPUTS	OUTPUTS
CODE ARTICLE	mm	mm	mm		m	ms				
CR0/0I-1V	10	69	109	7	0,2... 4,5	1,5	M12	4	None	b) IO_Link
CR0/0B-1V	10	69	109	7	0,2... 4,5	1,5	M12	5	d) NC/NO	b) PNP; c) NPN
CR0/0T-1V	10	69	109	7	0,2... 4,5	1,5	M12	4	d) NC/NO	b) Push-Pull
CR0/BP-1V	10	69	109	7	0,2... 4,5	1,5	M12	4	None	b) PNP-NO; c) PNP-NC
CR0/BN-1V	10	69	109	7	0,2... 4,5	1,5	M12	4	None	b) NPN-NO; c) NPN-NC

Tab.:1

**3.3 Functions description**

**3.3.1 Behavior at power-on**

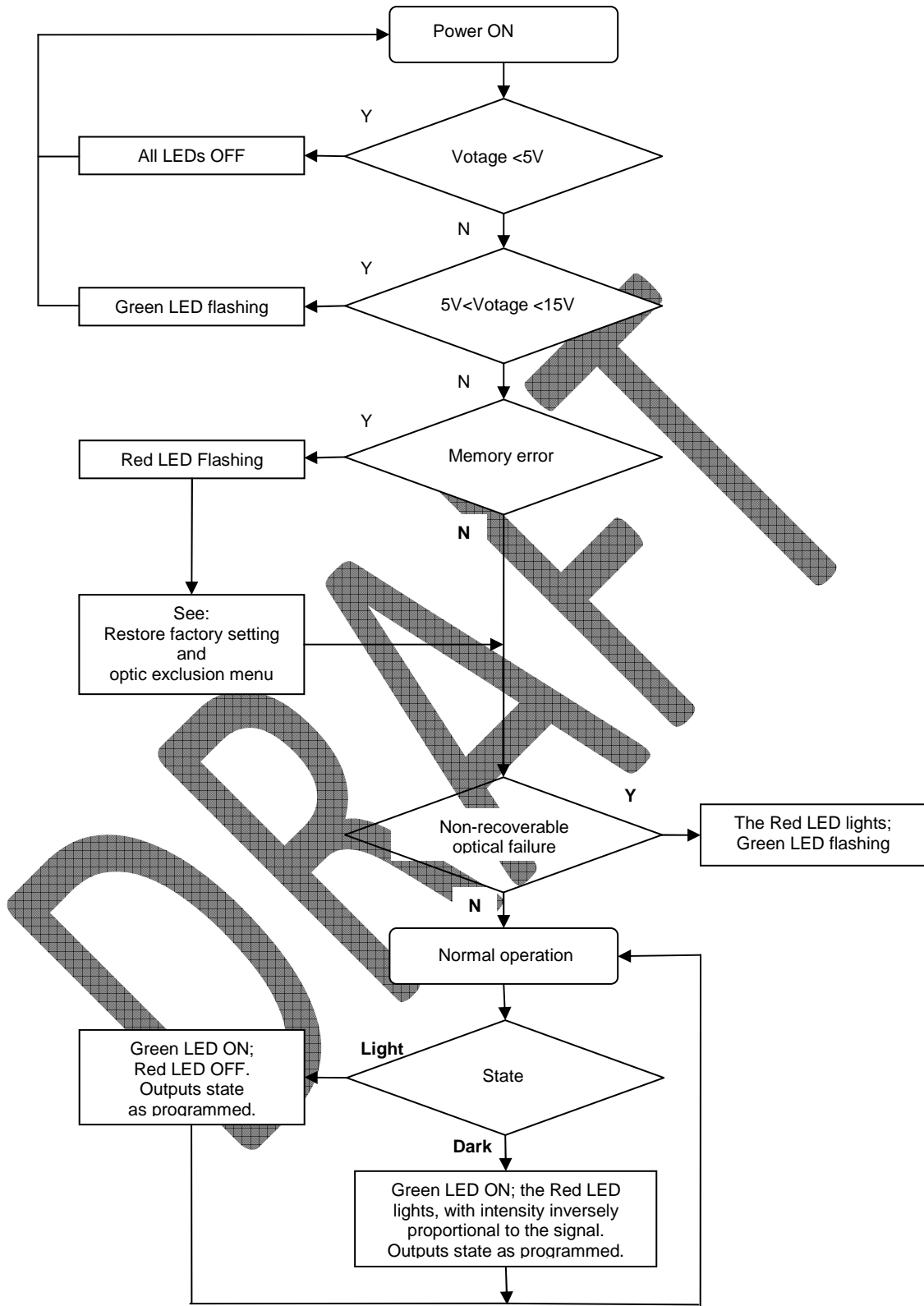



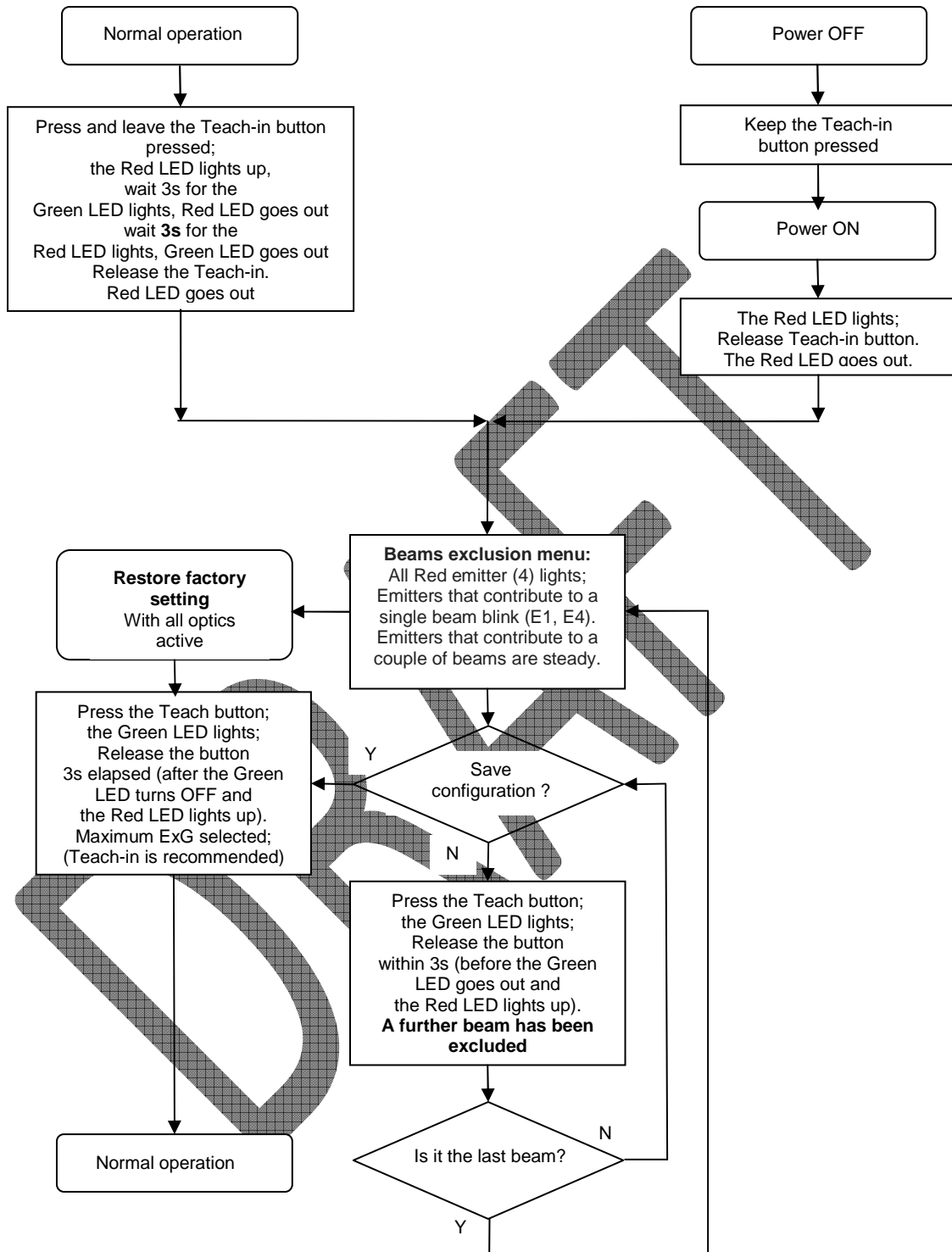

**3.3.3 Beams exclusion menu (blinking) and restore factory setting.**



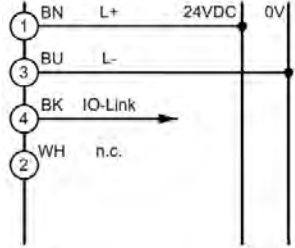

### 3.1 Electrical drawing

SERIE CRO	 REFLEX CURTAIN	CRO/OI MODEL IO-Link interface			
<b>M12, 4 poles Male connector</b>	<b>Wiring</b>	<b>Connector</b>			
		<b>Pin</b>	<b>Color</b>	<b>Signal</b>	<b>Description</b>
		1	BN	L+	Power supply input from 16 to 30V
		2	WH	n.c.	Not connected
		3	BU	L-	Supply voltage reference
		4	BK	C/Q	IO-Link interface

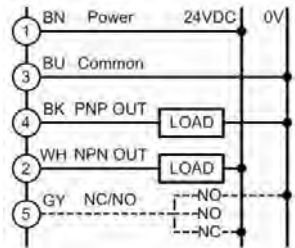

**NOTE:** No input or programming button.

Tab.:2

SERIE CRO	 REFLEX CURTAIN	CRO/OB MODEL PNP and NPN outputs, NC/NO selectable			
<b>M12, 5 poles Male connector</b>	<b>Wiring</b>	<b>Connector</b>			
		<b>Pin</b>	<b>Color</b>	<b>Signal</b>	<b>Description</b>
		1	BN	24V <sub>DC</sub>	Power supply input from 16 to 30V.
		2	WH	NPN Out	Apply a load connected at the positive, maximum current 100mA
		3	BU	0V	Supply voltage reference
		4	BK	PNP Out	Apply a load connected to the common, maximum current 100mA.
		5	GY or YE/GR	NC/NO	Input for outputs logic selection.

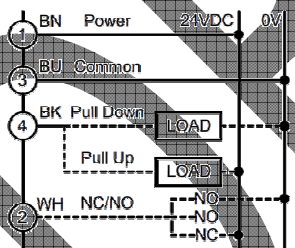

**NOTE:** The NC/NO input is read only when the sensor is switched ON. If it is left open or permanently wired to the common, it selects the output as LIGHT ON. If it is connected to the positive, it selects the output as DARK ON. Enabling the button it is possible to execute the teach.

Tab.:3

SERIE CRO	 REFLEX CURTAIN	CRO/OT MODEL Push Pull output, NC/NO selectable			
<b>M12, 4 poles Male connector</b>	<b>Wiring</b>	<b>Connector</b>			
		<b>Pin</b>	<b>Color</b>	<b>Signal</b>	<b>Description</b>
		1	BN	24V <sub>DC</sub>	Power supply input from 16 to 30V.
		2	WH	NC/NO	Input for outputs logic selection.
		3	BU	0V	Supply voltage reference.
		4	BK	Push Pull Out	Apply a Pull up or a Pull down load

**NOTE:** The NC/NO input is read only when the sensor is switched ON. If it is left open or permanently wired to the common the Push driver is Dark switching and the Pull driver is Light switching. If it is connected to the positive the Push driver is Light switching and the Pull driver is Dark switching.

Tab.:4

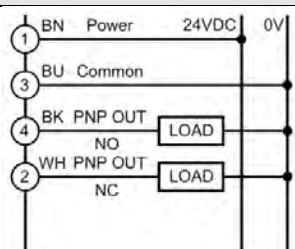

SERIE CRO	 REFLEX CURTAIN	CRO/BP MODEL PNP outputs NO and NC			
<b>M12, 4 poles Male connector</b>	<b>Wiring</b>	<b>Connector</b>			
		<b>Pin</b>	<b>Color</b>	<b>Signal</b>	<b>Description</b>
		1	BN	24V <sub>DC</sub>	Power supply input from 16 to 30V.
		2	WH	PNP Out NC	Apply a load connected to the common, maximum current 100mA.
		3	BU	0V	Supply voltage reference
		4	BK	PNP Out NO	Apply a load connected to the common, maximum current 100mA.

**NOTA:** Enabling the button it is possible to execute the teach.

Tab.:5

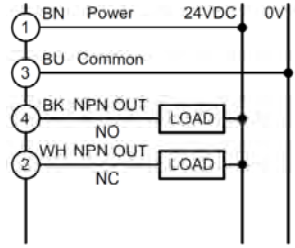

 <b>Micro Detectors</b> Italian Sensors Technology	<b>M.D. Micro Detectors</b> Strada S. Caterina, 235 41122 Modena Italy Tel. +39 059 420411 Fax +39 059 253973 www.microdetectors.com info@microdetectors.com	<b>CRO SERIES</b> <b>RETROREFLECTIVE AREA SENSOR</b>	<b>LANGUAGE</b>
		<b>Installation and Operation Manual</b>	<b>ENGLISH</b>

SERIE CRO	 <b>REFLEX CURTAIN</b>	<b>CRO/BN MODEL</b> NPN outputs NO and NC			
<b>M12, 4 poles</b> Male connector	<b>Wiring</b>	<b>Connector</b>			
		<b>Pin</b>	<b>Color</b>	<b>Signal</b>	<b>Description</b>
		1	BN	24V <sub>DC</sub>	Power supply input from 16 to 30V.
		2	WH	NPN Out NC	Apply a load connected to the positive, maximum current 100mA.
		3	BU	0V	Supply voltage reference
		4	BK	NPN Out NO	Apply a load connected to the common, maximum current 100mA.

**NOTA:** Enabling the button it is possible to execute the teach.

Tab.:6

#### 4.0 TECHNICAL SPECIFICATIONS

MODELS CRO					
OPTICAL PARAMETERS		Min.	Nom.	Max.	NOTE
Effective detection range <sup>1</sup>	m	0		4	Depend on reflector type (see table xxx)
Reflector range <sup>1</sup>	m	0.2		4	Standard displacement between sensor and reflector (see table xxx)
Excess gain 1 range <sup>1</sup>	m	0.1		5.6	Min/Max displacement between sensor and reflector (see table xxx)
Aperture angle	°			2.5	
Detection capability	mm	6			Diameter of a testing rod normal to the area (see table xxx)
Wavelength LEDs	nm		617		Red/Orange color, vertically polarized
Dark threshold level for a Teach_G			0.5		Ratio between Dark threshold level and signal level after a Teach-in
Light threshold level for a Teach_G			0.85		Hysteresis 30%
Dark threshold level for a Teach_F			0.8		Ratio between threshold value and signal relative to the LIGHT state
Light threshold level for a Teach_F			0.92		Hysteresis 15%
Immunity for artificial light, direct	Klux		50		Incandescent lamp
Immunity for artificial light, direct	Klux		5		Fluorescent lamp

**NOTES:** 1) It depends on the dimension and type of reflector, too close to the sensor the granularity of the reflector determine instability. Fine granularity increase minimum area and type determine maximum. The best active area dimensions of the reflector are 20x80mm.

 <b>M.D. Micro Detectors</b> Strada S. Caterina, 235 41122 Modena Italy Tel. +39 059 420411 Fax +39 059 253973 www.microdetectors.com info@microdetectors.com	<b>CRO SERIES</b> <b>RETROREFLECTIVE AREA SENSOR</b>			<b>LANGUAGE</b>
	<b>Installation and Operation Manual</b>			<b>ENGLISH</b>

MODELS CRO					
ELECTRICAL MCHANICAL PARAMETERS	Min.	Nom.	Max.	NOTES	
<b>Power supply</b>					
Operatin voltage	V	16	24	30	From PELV power supply according to EN 60204-1 Chap.6.4
Ripple	V			1,2	Supply voltage must stay within the stated limits
No load supply current	mA			100	Constant in the voltage range
<b>Digital Outputs</b>					
Output type (model <b>OI</b> )		C/Q			IO-Link, 4 wires, pin 2 not connected
Output type (model <b>OB</b> )		1xPNP, 1xNPN			Completely protected, selectable NO or NC, 5 wires
Output type (model <b>OT</b> )		1xPush-Pull			Completely protected, selectable NO o NC, 4 wires
Output type (model <b>BP</b> )		1xPNP NO; 1xPNP NC			Completely protected, 4 wires
Output type (model <b>BN</b> )		1xNPN NO, 1xNPN NC			Completely protected, 4 wires
Output type (model <b>OP</b> )		1xPNP			Completely protected, selectable NO o NC, 4 wires
Output type (model <b>ON</b> )		1xNPN			Completely protected, selectable NO o NC, 4 wires
Current	mA			100	Higher values are interpreted as overload or short circuit
Voltage drop @100mA	V	1,5		3	Reduction in output voltage compared to the supply voltage
Resistive load (at 24V)	Ω	280			Lower values are interpreted as short circuit
Leakage current, models <b>OI, OB, BP, BN</b>	μA			100	Value at which the OFF state of the load must be guaranteed
Leakage current, models <b>OT, OP, ON</b>	μA			10	Value at which the OFF state of the load must be guaranteed
Tolerated capacitive load	μF			0,7	Higher values can be interpreted as short circuit.
Switching time ON	μs		0,05		With load of 220/1000Ω
Switching time OFF	μs	2		10	With load of 220/1000Ω
<b>Response times</b>					
Time delay before availability	ms			450	All outputs are in the OFF state during this time
Teach-in	s			1	
Outputs response time	ms			1,2	All emission LEDs active (4 LEDs)
Switching frequency	Hz	600			All emission LEDs active (4 LEDs)
Output response time (formula)	ms	((N <sub>LED</sub> *0.1)+0.2)*2			N <sub>LED</sub> : number of active LEDs (not in Blanking)
<b>Input levels</b>					
Low level	V	0		0,8	Normally connected to common
Open level	V	1,3	1,9	2,35	Normally leaved open
High level	V	5,8		30	Normally connected to supply voltage
Integration time	ms		20		The input state must persist for at least this time
Input current for low level	μA	250		520	Outgoing or incoming current
Input current for high level	mA	0,52		1,2	Incoming current
<b>Teach -in time</b>					
Short push time	s	1		3	
Long time	s	8			
<b>Environmental parameters</b>					
Enclosure rating		IP67			Dust and water protection (immersion for 60 min. at a depth of 1m)
Working temperature	°C	-10		55	Without condensation
Storage temperature	°C	-25		70	To be respected also during transportation
Humidity	%			95%	Without condensation
Vibrations		Sec. IEC 60947-5-2			It complies with limits and conditions stated in the rule
Shock		Sec. IEC 60947-5-2			It complies with limits and conditions stated in the rule
<b>Sensing range correction factors</b>					
Environmental factors		0,50 / 0,25			In presence of dust, fog, smoke (approximate values)
<b>Connections</b>					
Cable sections	mm <sup>2</sup>		0,34		To be respected to guarantee the maximum indicated length
Lunghezza totale cavi di alimentazione	m			100	With cable of the indicated sections, standard models
Lunghezza cavi di interconnessione	m			20	Length of the connections: output, input, IO-Link
<b>Size/Material</b>					
Housing section	mm	20 (frontal) x 36			Painted aluminum, blue color <b>RAL5002</b>
Fixing groove for T shaped insert	mm	2/10/6,5			In the rear part of the sensor: depth/width/opening width
Width of the frontal window	mm	13mm			Effective width: 13mm central. Material: PMMA
Number/Size of the lenses		7*9*9mm			Central part of the window
Top closure	N°	1			Material: PC, transparent
Bottom closure	N°	1			Material: PBT + 30%GF, black colour
Closing screws	N°	2+2			M2, FE37 bronzed
<b>Connectors/Cables</b>					
Models <b>OI, OT, BP, BN, OP, OM</b>		1xM12, 4p, male			Pigtail length 240mm, PVC, Ø 4,7mm, 0,34mm <sup>2</sup>
Models <b>OB</b>		1xM12, 5p, male			Pigtail length 240mm, PVC, Ø 4,7mm, 0,34mm <sup>2</sup>

Tab.:9

 <p>M.D. Micro Detectors Strada S. Caterina, 235 41122 Modena Italy Tel. +39 059 420411 Fax +39 059 253973 www.microdetectors.com info@microdetectors.com</p>	<p style="text-align: center;"><b>CRO SERIES</b> <b>RETROREFLECTIVE AREA SENSOR</b></p> <p style="text-align: center;"><b>Installation and Operation Manual</b></p>	LANGUAGE
		ENGLISH

## 5.0 START-UP INSTRUCTIONS

### 5.1 Mechanical mounting of CR models

It is extremely important to fix the sensors and the reflectors to a rigid structure, not subject to deformation or to strong vibrations. Choose the position of the sensor so as not to expose it to strong sources of natural or artificial light and to light interference with other sensors in the visible emission.

Keep in mind that the devices are not suitable for outdoor installation, IP67 despite being declared, it is not guaranteed that the long exposure to the weather does not cause water penetration and performance degradation. Choose the most suitable reflector to the required detection capabilities and sensing range.

Mount the sensor with the optical axes as much as possible perpendicular to the reflector surface. The mutual distance depends on the type of reflector and must be included in the field of specification. To secure the sensors to a support, use the corresponding inserts to be applied in the rear groove and the brackets in the normal provisioning.

If the application is subject to vibrations, which anyway do not prevent the optical alignment, use damping supports.

Though used polarized light, the light beams can in part be deflected by reflective surfaces parallel and near to the beams, this can lead to a missed detections of the interruption of direct path of the of the optical beam, or incorrect calibration values that may generate unstable operation, so all reflective surfaces and reflective objects should maintain a minimum distance from the direct path of the rays. This distance depend on the aperture angle of optics.

Keep in mind that even if a surface is black, if it is shiny, it can be highly reflective.

**If you can't eliminate or reduce the effect of a reflective surface, it is important that this effect remains stable or that the system behaves in an acceptable and predictable manner.**

Temporarily block the sensor and reflector so that they are aligned and parallel to each other.

### 5.1 Electrical installation

Use **PELV** power supplies, in compliance with Chap.6.4. of EN 60204-1.

If using a non-stabilized power supply, the transformer must have double insulation and adequate power, the secondary winding must not exceed 18Vac. Use a bridge rectifier, a filtering capacitor with a minimum value of 1000µF.

Connect the supply cables directly to the source and not downstream of other power or highly inductive devices.

Run the cables of the light curtains in dedicated raceways or where only signals run; do not use raceways already carrying power cables.

Comply with the specification of the maximum length of the connection cables. Make sure that the part or parts of the metal structure on which the sensors are installed are effectively connected to the same earth ground.

Before inserting the connector, check that the mains voltage and the supply voltage are within the required limits, apply the connector and check again that the supply voltage has a correct nominal value and remains within the limits defined in all working conditions. Check the limits in the two extreme conditions of minimum and maximum absorption of all devices connected to the same power supply, especially if this is **not** a stabilized power supply.



#### Danger!

In order to carry out the following operations, a voltage supply to the sensor is needed. Before starting this phase, make sure that the outputs' switch cannot lead to any danger.

Make the minimum electrical connections for proper operation, connect the power cables, connected to the necessary inputs devices; suitably connected the NC / NO input if it is available, this status is only acquired at power on.

### 5.2 Alignment of CR0 models

Applied the supply voltage, the Green LED must be switched on, if it is off or flashes the supply voltage is not sufficient.

Verify that the emission optics are active and therefore emit a red light, if necessary make a teach-in (even without visibility of the reflector) with the purpose to activate the alignment function. If possible, observe the reflector from a point near the optical axis and corrects the alignment so that the light stain completely illuminate the reflector, simultaneously or alternatively use the alignment function of the Red and Green LED (reduce the red light to a minimum).

Fix the sensor and run now a Teach\_F and check the status of the LEDs, if the Red LED is off and the Green on, the alignment was acceptable and the Teach was successful. If both LEDs are still blinking it means that the alignment is incorrect, so try to get a better alignment then run a second Teach G or F. After successfully aligned, permanently block the sensor and verify that the sensor detects properly as expected. If possible, urging the structure, verify that the vibrations do not cause unstable operation.

If the LEDs show no recognizable behaviors check the error codes in **Chapter 5.5**







#### Indication

A correct optical alignment with a good signal margin prevents unstable functioning of the light curtains, reduces optical interferences and reflection by shiny surfaces and guarantees better stability in general.









If the range is short, the graininess of the reflector can cause instability, check the behaviour of the system by shifting the reflector, as an alternative use of reflective paper composed of micro prisms.

Please do not forget to reconnect all the cables and to control the correct functioning of the application.























### 5.5 Display indications and diagnostics.

MEANINGS OF LEDs SIGNALLING MODES	
	Indication of full light and steady
	Indication of low intensity or intermittently with fast periodic flashing
	Indication of slow continuous flashing
	Off

Tab.:10

LEDs INDICATIONS				
<b>GN</b>		No power supply or below 5V. Memory reading error.		Light state. No power supply.
		Power supply below 16V. Emission LEDs failed.		Memory reading error.
		Alignment. Outputs in short circuit		Alignment. Some optics in Dark
		Normal operation.		Many or all optics in the DARK Fault or outputs in short circuit

Tab.:11

COMBINED INDICATIONS							
							
							
<b>GN</b>							
<b>RD</b>							
<b>STATUS</b>	 <b>Power</b>	 <b>MEMORY ERROR</b>	 <b>FAULT</b>	 <b>LIGHT</b>	 <b>DARK</b>	 <b>ALIGNEMENT</b>	 <b>Out</b>
	OFF or LOW	MEMORY ERROR	FAULT	LIGHT	DARK	ALIGNEMENT	OVERLOAD

Tab.:12

**6.0 MECHANICAL DIMENSIONS OF LIGHT CURTAINS AND STANDARD ACCESSORIES**

**6.1 Mechanical dimensions of CR0/\*\*-1V reflex curtains**

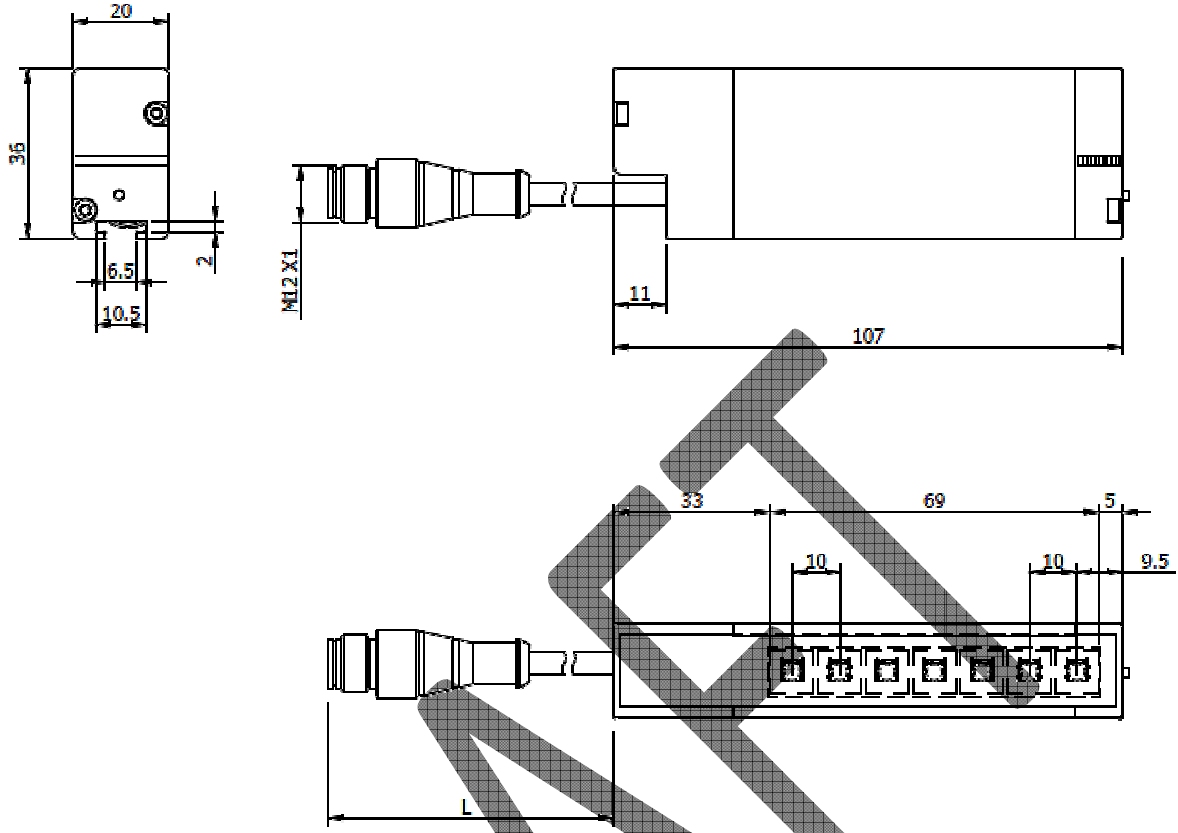

**Picture 1**  
Pigtail cable length **L = 240mm**

**6.2 Standard Mounting accessories**

One unit is supplied by type

**Kit mounting accessories ST151**

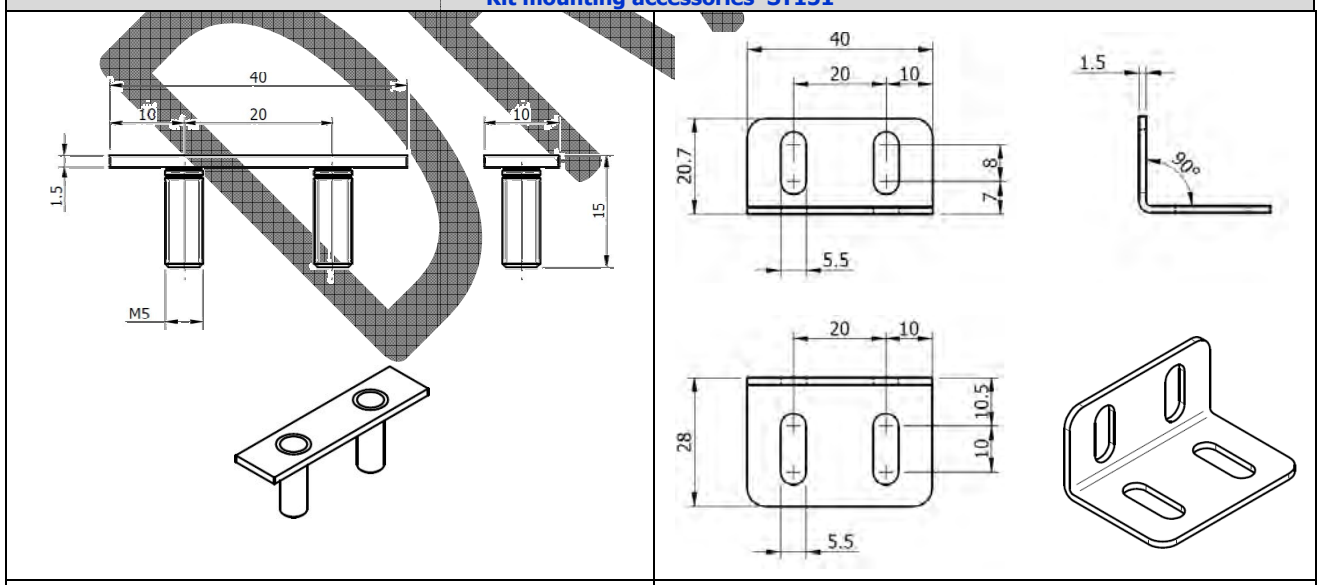

**Picture 2**  
T-shaped insert, with two M5 nuts and two split washers.

**Picture 3**  
L-shaped mounting bracket

 <p>M.D. Micro Detectors Strada S. Caterina, 235 41122 Modena Italy Tel. +39 059 420411 Fax +39 059 253973 www.microdetectors.com info@microdetectors.com</p>	<b>CRO SERIES</b> <b>RETROREFLECTIVE AREA SENSOR</b>	<b>LANGUAGE</b>
	<b>Installation and Operation Manual</b>	<b>ENGLISH</b>

## 7.0 INSTALLATION

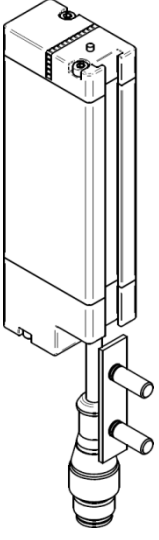
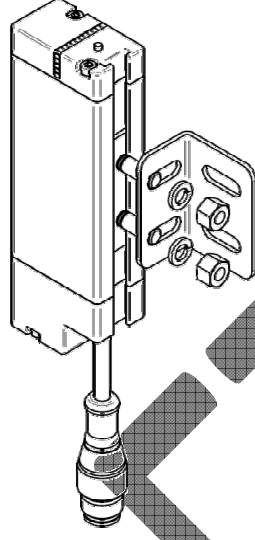
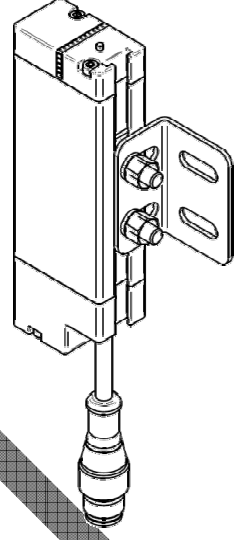
Securing CRO light curtains with accessories' kit ST151		
		
Place the T-shaped insert	Mount the L-shaped bracket on the T-shaped insert <b>Picture 2</b>	Secure light curtains to the wall

## 8.0 LIST OF AVAILABLE ACCESSORIES

M12 CONNECTORS, 4 POLES, WITH CABLE	
<b>CD12M/OB-020A1</b>	M12 connector, straight, 4 poles, female, 2m PVC cable
<b>CD12M/OB-050A1</b>	M12 connector, straight, 4 poles, female, 5m PVC cable
<b>CD12M/OB-100A1</b>	M12 connector, straight, 4 poles, female, 10m PVC cable
M12 CONNECTORS, 4 POLES, WITH CABLE	
<b>CD12M/OB-050A5</b>	M12 connector, straight, 4 poles, female, 5m PUR cable
<b>CD12M/OB-100A5</b>	M12 connector, straight, 4 poles, female, 10m PUR cable
M12 CONNECTORS, 5 POLES, WITH CABLE	
<b>CD12M/OH-050A5</b>	M12 connector, straight, 5 poles, female, 5m PUR cable
<b>CD12M/OH-100A5</b>	M12 connector, straight, 5 poles, female, 10m PUR cable
STANDARD MOUNTING KIT FOR LIGHT CURTAINS	
<b>ST151</b>	Kit with T-shaped insert with four M5 screws complete with nuts and washers and an L-shaped bracket
VIBRATION DAMPING SUPPORTS	
<b>ST 4V S</b>	Kit of 4 vibration-damping supports

## 9.0 PACKAGE CONTENT

Each package has the following content:

- A light curtains.
- An accessories' kits ST151 (T-shaped insert and L-shaped bracket)
- Multilingual installation short manual.



 <p>M.D. Micro Detectors Strada S. Caterina, 235 41122 Modena Italy Tel. +39 059 420411 Fax +39 059 253973 www.microdetectors.com info@microdetectors.com</p>	<b>CRO SERIES</b> <b>RETROREFLECTIVE AREA SENSOR</b>		<b>LANGUAGE</b>
	<b>Installation and Operation Manual</b>		<b>ENGLISH</b>

## 10.0 CONTROL OF THE INSTALLED LIGHT CURTAINS

### 10.1 Purpose of controls.

The controls described here below are meant to ensure the functional and reliable performances required.

### 10.2 Preliminary controls before start-up

- All devices must be correctly installed and well secured.
- The maximum response time must be adequate to the application. Make sure that the sensor's response time is compatible with the specific application, detecting objects of minimum and maximum size, in different positions and, if possible, with even faster movements compared to what the application allows.
- Make sure that no optically interfering devices are in the visual field of the sensor. Make sure that other devices do not undergo interferences by the emitted light.
- Make sure that sensors are not exposed to any substance which might dirty or damage the optics.
- Make sure that technical documentation is available for operators in charge of maintenance.

### 10.3 Controls device efficiency

- State and efficiency of the device can be checked using a test stick, which must be detected in a way that is repetitive in time.
- Make sure that there are no damages nor dirt on optical windows' surface. Scratches and tarnished surfaces can negatively affect the light curtain's resolution.
- If necessary, clean the optical surface with a humid antistatic cloth. Do not use any alcohol, nor solvents, nor abrasive substances.

## 11.0 CE-CONFORMITY DECLARATION

TO BE DEFINED.

## 12.0 WARRANTY

TO BE DEFINED.

DRAFT